

T2™

Supracondylar Nailing System

Operative Technique

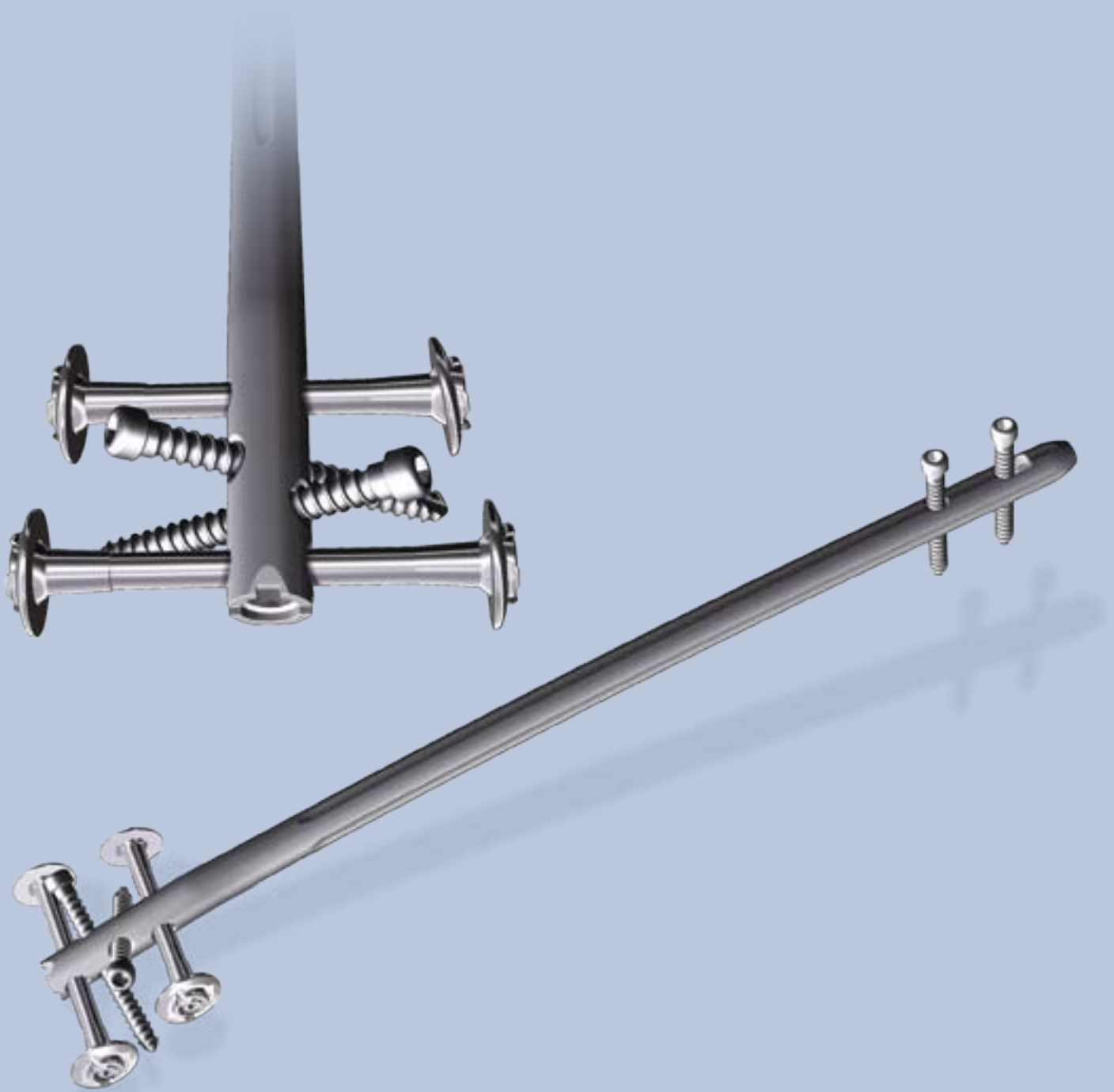

Supracondylar Nailing System

Contributing Surgeons:

Prof. Dr. med. Volker Bühren

Chief of Surgical Services
Medical Director of Murnau Trauma Center
Murnau
Germany

Dean C. Maar, M.D.

Methodist Hospital - Indianapolis
Indianapolis
Indiana
USA

James W. Maxey, M.D.

Orthopedic Institute of Illinois
Peoria
Illinois
USA

This publication sets forth detailed recommended procedures for using Stryker Trauma devices and instruments.

It offers guidance that you should heed, but, as with any such technical guide, each surgeon must consider the particular needs of each patient and make appropriate adjustments when and as required.

A workshop training is required prior to first surgery.

Contents

1.	Introduction	4
1.1.	Implant Features	4
1.2.	Instrument Features	6
1.2.1.	Target Device Features	6
1.2.1.1.	Target Device Features (Targeting Arm, SCN)	6
1.2.1.2.	Target Device Features (Targeting Arm Proximal, SCN)	6
2.	Locking Options	8
3.	Indications	9
4.	Pre-operative Planning	9
5.	Operative Technique	10
5.1.	Patient Positioning	10
5.2.	Incision	10
5.3.	Entry Point	11
5.4.	Reamed Technique	12
5.5.	Nail Selection	13
5.6.	Nail Insertion	14
5.7.	Guided Distal Locking Mode	15
5.7.1.	Proximal Locking - Fully Threaded Screw	15
5.7.2.	Proximal Locking - Condyle Screw	17
5.7.3.	Oblique Locking - Fully Threaded Screw	18
5.7.4.	Distal Locking - Fully Threaded or Condyle Screw	19
5.8.	Freehand Proximal Locking	20
5.9.	Guided Proximal Locking SCN Short	21
5.10.	End Cap Insertion	22
5.11.	Nail Removal	23
<hr/>		
	Ordering Information - Implants	24
	Ordering Information - Instruments	26

Introduction

1. Introduction

Over the past several decades ante-grade femoral nailing has become the treatment of choice for most femoral shaft fractures. Recently, retrograde femoral nailing has increased in popularity, expanding the use of intramedullary nails. Complicated multiple trauma injuries, ipsilateral femoral neck and shaft fractures, associated pelvic and acetabular fractures, ipsilateral femoral and tibial shaft fractures, supracondylar and intercondylar fractures, may be better managed by utilizing retrograde femoral nailing techniques.

In addition to the **T2™ Femoral Nailing System**, Stryker Trauma developed the **T2™ Supracondylar Nail (SCN)** for the treatment of complex distal femoral fractures.

The **T2™ Supracondylar Nailing System** offers the advantages of a unique locking configuration and targeting concept, allowing superior fixation in the distal femur, using the already established T2 instrument platform and locking screws.

1.1. Implant Features

The **T2™ SCN System** is the realization of superior biomechanical intramedullary stabilization using small caliber, strong and cannulated implants for internal fixation of the femur.

According to the fracture type, the system offers the option of a static locking mode with 3 plane fixation.

The design of the **T2™ SCN System** is universal for left and right indications.

Two implant versions are available:

Short version:
Proximal Targeting via Target Device

Long version:
Proximal Locking via Freehand Locking

Nails:
T2™ SCN Short version
Length : 170 & 200mm

T2™ SCN Long version
Length: 240–440mm in 20mm increments

SCN End Cap:

One End Cap for all **T2™ SCN** is available to lock the most distal Locking Screw in order to avoid lateral movement of the nail and to prevent bony ingrowth. This feature creates a fixed angle between the nail and Locking Screw.

Common 5mm cortical screws simplify the surgical procedure and promote a minimally invasive approach. Fully Threaded Screws are available for standard locking procedures.

Special Condyle Screws with adjustable screw heads for improved fit are designed to fix fragments in the condyle area. They provide compression of intracondylar fractures and increased stability in distal fracture fragment.

All implants of the **T2™ SCN System** are made of Type II anodized **titanium alloy (Ti6Al4V)** for enhanced **biomechanical and biomedical performance.**

Technical Details

Nails

Diameter 9–14mm
 Short Version 170 & 200mm
 Long Version 240–440mm

5.0mm Fully Threaded Locking Screws
 L = 25–120mm



5.0mm Condyle Screws
 L = 40–120mm



Note:
 Screw length is measured from top of head to tip.

Condyle Nut



End Caps



Instruments

1.2. Instrument Features

The major advantage of the instrument system is a breakthrough in the integration of the instrument platform which can be used not only for the complete T2™ Nailing System, including the T2™ SCN System, but will be the platform for all future nailing systems, reducing complexity and inventory.

The instrument platform features ergonomically styled targeting devices, and provides advanced precision while maintaining ease of use.

Additionally, the instruments are color, number and symbol coded indicating their usage during the surgical procedure.

Color and number coding indicates the step during the procedure in which the instrument is used. This color code system is marked on the trays to easily identify the correct instrument.

Step	Color	Number
Opening	Red	①
Reduction	Brown	②
Nail Introduction	Green	③
Guided Locking	Light Blue	④
Freehand Locking	Dark Blue	⑤

Symbol coding on the instruments indicates the type of procedure and must not be mixed.

Symbol

■ = Long instruments

Drills

Drills feature a color coded ring:

4.2mm = **Green**
For Fully Threaded Screws 5.0mm

5.0mm = **Black**
For Condyle Screws

1.2.1. Target Device Features

1.2.1.1. Target Device Features (Targeting Arm, SCN)

The Targeting Arm for the T2™ SCN is designed with one locking hole for all locking screws to be placed in the distal femur (Fig. 1).

These are the locking holes in the distal femur:

1. Proximal Transverse Distal Condylar Locking
2. Oblique Condylar Locking
3. Oblique Condylar Locking
4. Distal Transverse Distal Condylar Locking

The Targeting Arm can be rotated and axially moved along the Nail Adapter. The Locking Window, together with the corresponding positions on the Targeting Arm indicates the appropriate locking position.

After the required locking position is reached, the Targeting Arm is locked by tightening the thumb screw.

Note:

To avoid mis-drilling the Targeting Arm can be locked in the dedicated position only.

1.2.1.2. Target Device Features (Targeting Arm Proximal, SCN)

An additional Target Device **for the T2™ SCN Short version** is available for the proximal locking options: The name of this Target Device is: Targeting Arm Proximal, SCN (Fig. 2).

After the required locking position is reached, the Targeting Arm is locked by tightening the thumb screw.

The Targeting Arm Proximal, SCN, is designed to provide guided proximal locking for the T2 SCN Short version 170 & 200mm.

Instruments

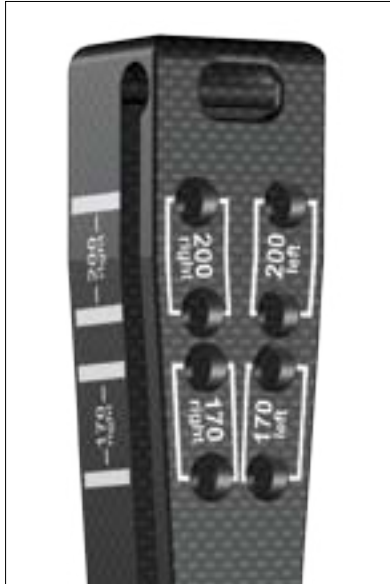

Targeting Arm Proximal, SCN (1806-3305)

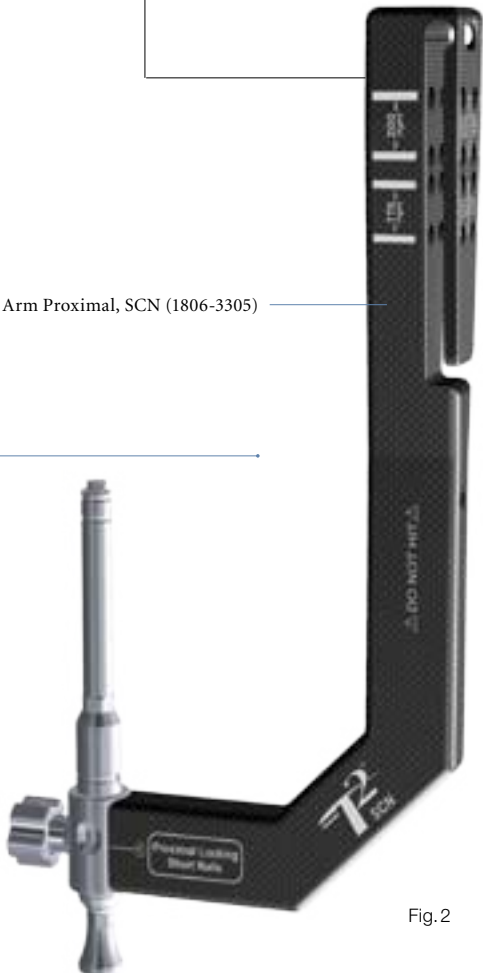

Fig.2

Targeting Arm, SCN (1806-3302)

Target Hole

Safety Clip

Nail Adapter, SCN (1806-3301)

- Proximal Transverse Distal Condylar Locking 1
- Oblique Condylar Locking 2
- Oblique Condylar Locking 3
- Distal Transverse Distal Condylar Locking 4

Nail Holding Screw, SCN (1806-3307)



Thumb Screw

Locking Window

Fig. 1



Indications

2. Locking Options

Proximal Locking Options T2™ SCN Long version

When treating distal fractures, two A/P screws should be used in static position when possible (Fig. 6). Proximal locking may be done in either static or dynamic mode depending on surgeon preference. These holes are targeted freehand.

Proximal Locking Options T2™ SCN Short version

When treating distal fractures, two M/L locking screws should be used when possible (Fig. 7). Both screws can be placed directly through the Targeting Arm Proximal, SCN.

Distal Locking Options T2™ SCN Short and Long version

The different distal screw positions for both T2™ SCN versions are (sequence of recommended insertion, Fig. 5):

- 1 **Transverse Screw:**
Condyle Screw or Fully Threaded Screw
- 2 **Oblique Screw:**
Fully Threaded Locking Screw
- 3 **Oblique Screw:**
Fully Threaded Locking Screw
- 4 **Transverse Screw:**
Condyle Screw or Fully Threaded Screw

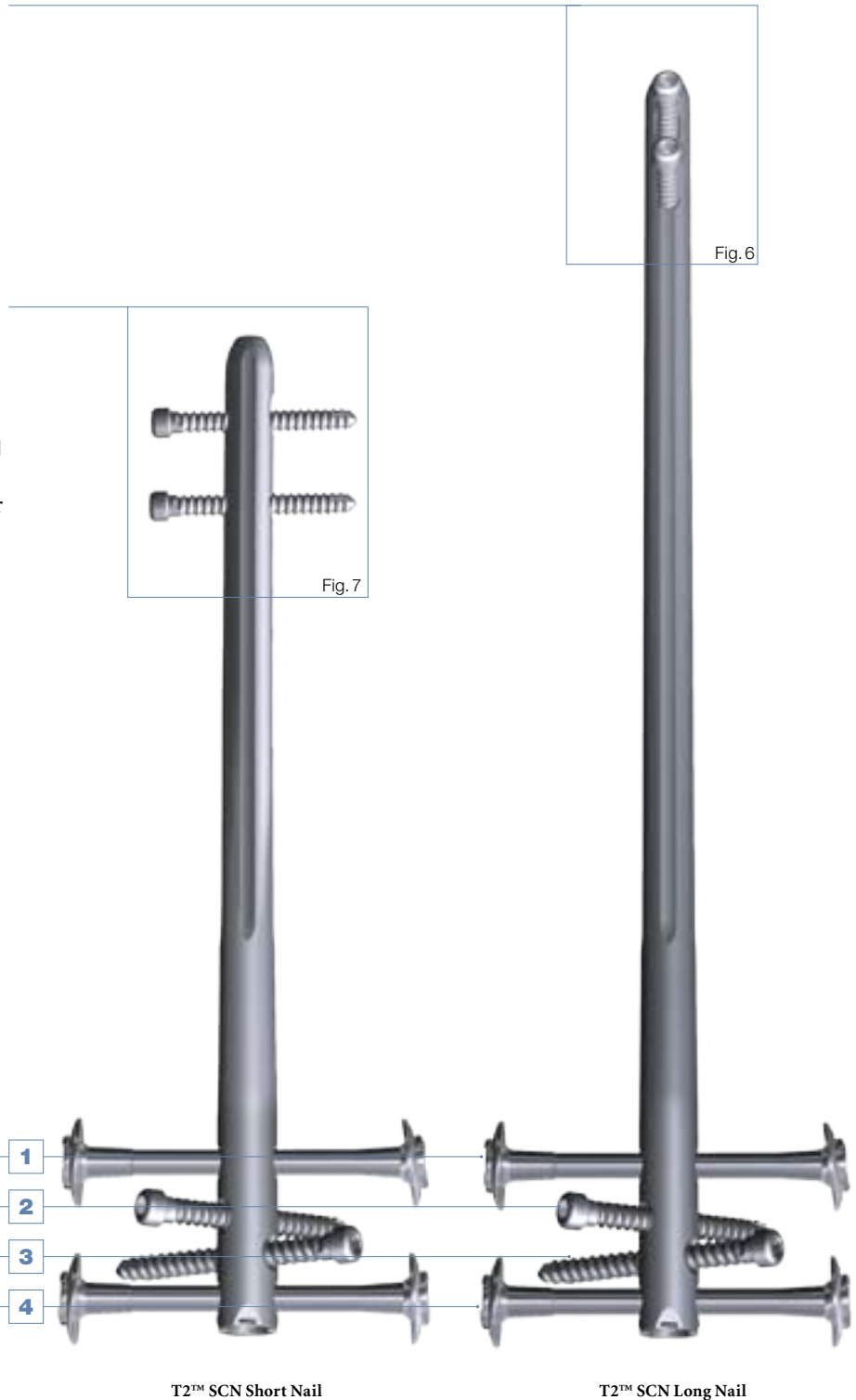

Fig. 5

Indications

3. Indications

The T2™ SCN System is indicated for:

- Open and closed femoral fractures
- Pseudoarthrosis and correction osteotomy
- Pathologic fractures, impending pathologic fractures, and tumor resections
- Supracondylar fractures, including those with intra-articular extension
- Fractures distal to a Total Hip Prosthesis
- Nonunions and malunions

4. Pre-operative Planning

An X-Ray Template (1806-3306) is available for pre-operative planning (Fig. 3).

Thorough evaluation of pre-operative radiographs of the affected extremity is critical. Careful radiographic examination of the trochanteric region and intercondylar regions can prevent intra-operative complications.

The nail length of the T2™ SCN **Long version** is determined by measuring the distance between a point 5mm–15mm proximal to the Intercondylar Notch to a point at/or to the Lesser Trochanter.

The nail length of the T2™ SCN **Short version** will depend on the fracture site. Available lengths are 170mm and 200mm.

Note:

Check with local representative regarding availability of nail sizes.



Fig. 4

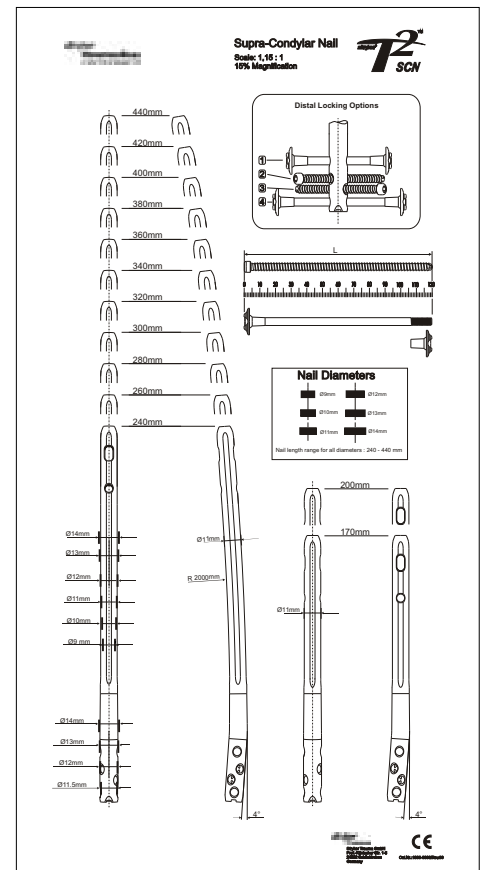

Fig. 3

Operative Technique

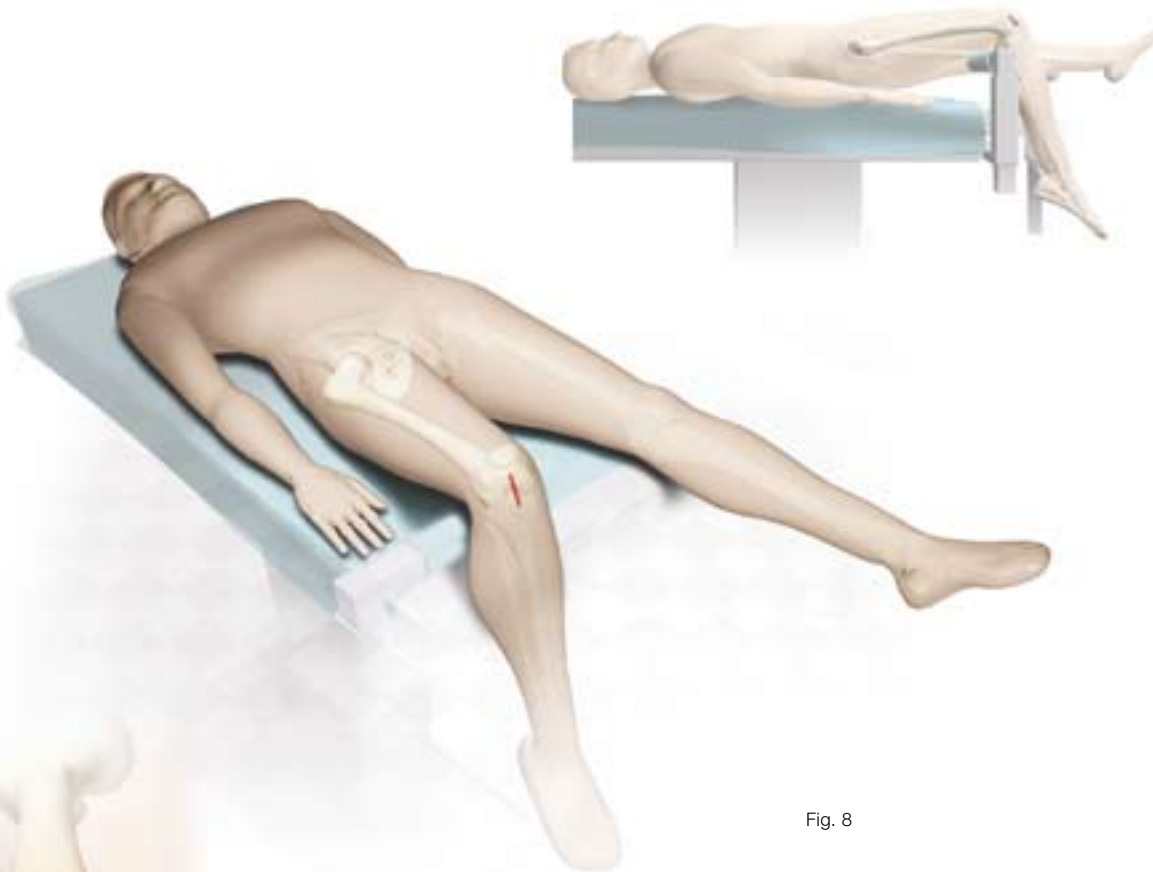

Fig. 8

5. Operative Technique

5.1. Patient Positioning

Retrograde nail insertion is performed with the patient supine on a radiolucent table. The affected lower extremity and hip region are freely draped, and the knee is placed over a sterile bolster. This will allow knee flexion. Manual traction through a flexed knee or a distraction device may be used to facilitate reduction for most femoral fractures (Fig. 8).

5.2. Incision

A 3cm midline skin incision is made extending from the inferior pole of the Patella to the Tibial Tubercle, followed by a medial parapatellar capsular incision (Fig. 9). This should be sufficient to expose the Intercondylar Notch for retrograde nail insertion.

Occasionally, a larger incision may be needed, especially if the fracture has intra-articular extension and fixation of the condyles is necessary.

Distal femoral fractures are often complicated by intra-articular fracture line extension. These fractures should be anatomically reduced and secured. Titanium AsnisIII® Cannulated Screws should be used with a combination of bone holding clamps to secure the Intracondylar region for nail insertion. The design of the T2™ SCN Nail allows for further fixation and compression using the T2™ Condyle Screws. Care should be taken with Cannulated Screws placement not to interfere with the nail insertion. An alternative is to reduce and maintain reduction of the femoral condyles with a pointed reduction forceps. Only, utilizing the Cross Locking Screws for definite fixation.



Fig. 9

Operative Technique

5.3. Entry Point

Note:

Entry point preparation is key to this operation and critical for excellent results.

The 3×285mm K-Wire (1806-0050S)* can be fixed to the Guide Wire Handle (1806-0095 and 1806-0096) (Fig. 10). With fractures of the condyles secured, the entry point for T2™ SCN insertion is made by centering the 3×285mm K-Wire through the Retrograde Protection Sleeve (703165) and positioning within the Intercondylar Notch anterior to Blumensaat's line on the M/L radiograph (Fig. 11a) using the Slotted Hammer (1806-0170).

This point is found by palpating a distinct ridge just anterior to the Posterior Cruciate Ligament. The K-Wire placement should be verified with A/P and Lateral radiographs (Fig. 11a & 11b).

The K-Wire is advanced 10cm, confirming its placement within the center of the distal femur on an A/P and Lateral radiograph.

The Retrograde Protection Sleeve is contoured to fit the profile of the Intercondylar Notch. It is designed to help reduce the potential for damage during reaming, and also provide an avenue for the reamer debris to exit the knee joint (Fig. 12).

When the inner Retrograde K-Wire Guide is removed, the distal most



Fig. 10



Fig. 11a

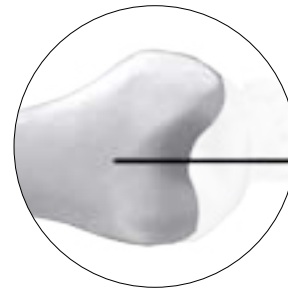

Fig. 11b

8cm of the femur has to be reamed carefully. The entry portal has to be carefully enlarged using the Bixcut reamer set starting from 6.5mm in 0.5 increments through the Retrograde Protection Sleeve (Fig. 13).

Alternatively, when patient anatomy allows, the Ø12mm Rigid Reamer (1806-2012) is inserted over the 3×285mm K-Wire and through the Retrograde Protection Sleeve. The distal most 8cm of the femur is reamed slowly and carefully.

Note:

Prior to advancing the K-Wire within the distal femur, check the correct guidance through the Ø12mm Rigid

Reamer. Do not use bent K-Wires.

Optionally, the cannulated Awl (1806-0045) may be used to open the canal.

Note:

During opening the entry portal with the Awl, dense cortex may block the tip of the Awl. An Awl Plug (1806-0032) can be inserted through the Awl to avoid penetration of bone debris into the cannulation of the Awl shaft.

* Outside of the U.S., product with an "S" may be ordered non-sterile without the "S" at the end of the corresponding Cat. Number.



Fig. 12



Fig. 13

Operative Technique

5.4. Reamed Technique

Note:

Fracture reduction should be performed prior to placement of the guide wire.

For the reamed technique, the 3×1000mm Ball Tip Guide Wire (1806-0085S)* is inserted through the fracture site and does not require a Guide Wire exchange. The Universal Rod with Reduction Spoon may be used as a fracture reduction tool to facilitate Guide Wire insertion through the fracture site (Fig. 14).

Note:

The Ball Tip at the end of the Guide Wire will stop the reamer head and facilitate the removal of a broken reamer head.

Note:

It is essential that all bone fragments are reduced prior to reaming.

Reaming (Fig. 15) of the femur should be performed very carefully and is commenced in 0.5mm increments until chatter or cortical contact is appreciated. Final reaming should be 1mm larger than the diameter of the nail to be inserted.

Note:

If any provisional fixation screw used in reducing the fractures are in the line of the reamer they should be repositioned.

Note:

Thoroughly irrigate the knee joint to remove any debris.

* Outside of the U.S., Locking Screws and other specific products may be ordered non-sterile without the "S" at the end of the corresponding Cat. Number.



Fig. 14



Fig. 15

Operative Technique

Bixcut™ Reamer

The complete range of Bixcut™ reamers is available with either modular or fixed heads.

The optimized cutting flute geometry is designed to significantly reduce intramedullary pressure and temperature.

This is achieved by the forward and side cutting face combination and large clearance rate resulting from a reduced number of reamer blades coupled with reduced length of reamer head to give effective relief of pressure and efficient removal of material.

5.5. Nail Selection

Diameter

The diameter of the selected nail should be 1mm smaller than that of the last reamer used.

Length

Nail length may be determined by measuring the remaining length of the Guide Wire. The Guide Wire Ruler (1806-0020) may be used by placing it on the Guide Wire and reading the correct nail length at the end of the Guide Wire on the Guide Wire Ruler (Fig. 16 & Fig. 17). The calibration is based on the use of either an 800mm or 1000mm Guide Wire. The Guide Wire Ruler is marked for both options.

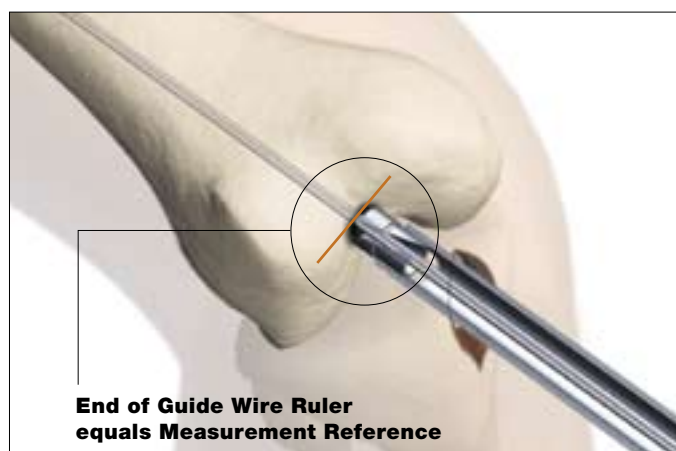
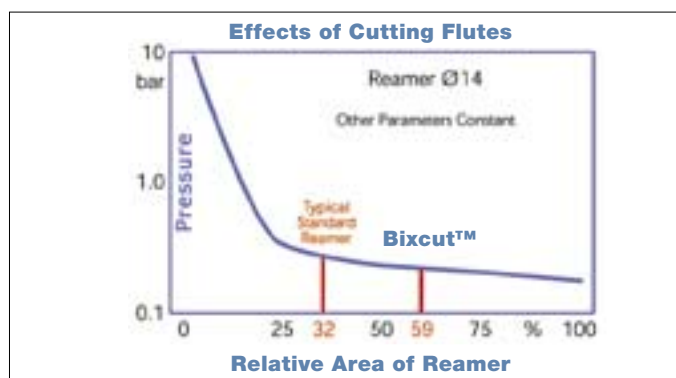
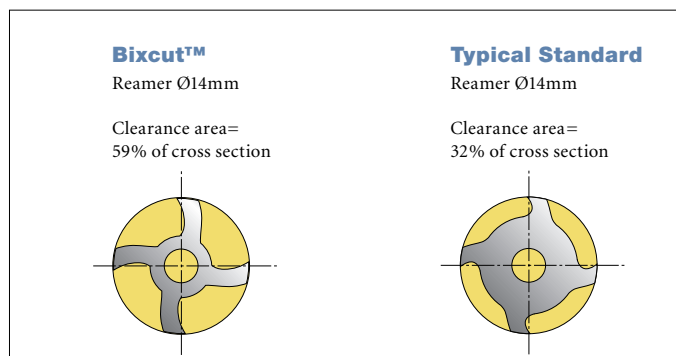

Fig. 16



Fig. 17



Operative Technique

5.6. Nail Insertion

The selected nail is assembled onto the Nail Adapter (1806-3301) with the Nail Holding Screw, SCN (1806-3307) (Fig. 18).

Tighten the Nail Holding Screw with the Spanner 10mm (1806-0130) and the Spanner 12mm (1114-6004) acting as the counter force (Fig. 19).

For assembling the T2 SCN Short version follow the same instructions.

Note:

Curvature of the nail must match the curvature of the femur.

The Slotted Hammer (1806-0170) can be used on the Nail Holding Screw (Fig. 20) or, if dense bone is encountered, the Universal Rod (1806-0110) may be attached to the Nail Holding Screw and used in conjunction with the Slotted Hammer to insert the nail.

Note:

Only hit the Nail Holding Screw.

For repositioning the nail, the Universal Rod and the Slotted Hammer may be attached to the Nail Holding Screw to carefully and smoothly extract the assembly.

Unique to the T2™ SCN System, the Guide Wire Ball Tip, 3×1000mm (1806-0085S) does not need to be exchanged.

Note:

Remove the Guide Wire prior to drilling and inserting the locking screws.

When inserting the T2™ SCN, the nail should be counter-sunk below the Subchondral bone using Blumensaat's line as a reference (Fig. 21). The Nail Adapter has a marking at 10mm to allow for a reference with fluoroscopy.

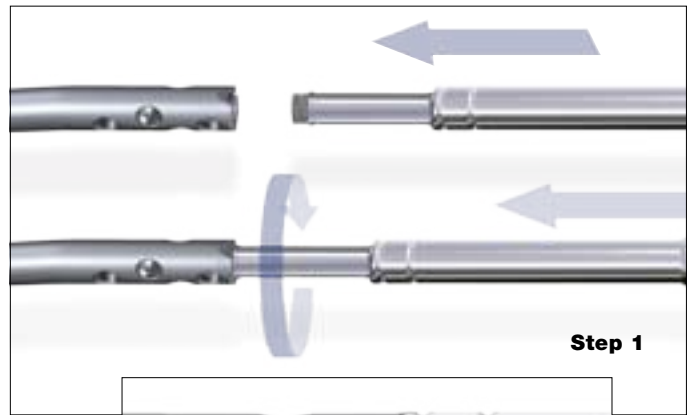

Fig. 18



Fig. 19



Fig. 20

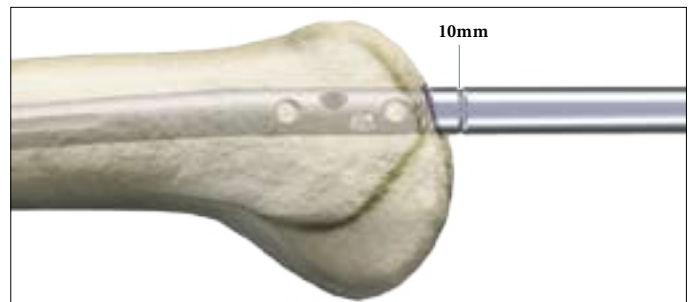

Fig. 21

The nail can never be left proud as this will destroy the Patella cartilage. Correct seating is verified with a lateral flourosopic image with the condyles superimposed. The distal nail tip should be proximal to the subchondral line.

Operative Technique

5.7. Guided Distal Locking Mode

The Targeting Arm, SCN (1806-3302) is assembled onto the Nail Adapter, SCN.

Note:

When treating distal fractures, four screws should be used whenever possible.

Note:

The order of locking is case dependent.

5.7.1. Proximal Locking - Fully Threaded Screw

Turn the Targeting Arm around the Nail Adapter until it is locked in the M/L plane to gain access to the most proximal of the distal locking holes (Fig. 22).

The position 1 is fixed by tightening the thumb screw.

Note:

Check that the position 1 is indicated in the Locking Window (Fig. 23).

The Long Tissue Protection Sleeve (1806-0185) together with the Long Drill Sleeve (1806-0215) and the Long Trocar (1806-0315) are inserted into the Targeting Arm by pressing the Safety Clip (Fig. 24).

The mechanism will keep the sleeve in place and prevent it from falling out. It will also prevent the sleeve from sliding during screw measurement. To release the Tissue Protection Sleeve, the Safety Clip must be pressed again.

A small skin incision is made, and the assembly is pushed through until it is in contact with the lateral cortex of the Femur (Fig. 24).

The Long Trocar is removed, with the Long Tissue Protection Sleeve and the Long Drill Sleeve remaining in position (Fig. 25).

Depending on the fracture pattern and the bone quality, either a Fully Threaded Screw (see Chapter 5.7.1.) or a Condyle Screw (see Chapter 5.7.2.) can be used for the most proximal locking.

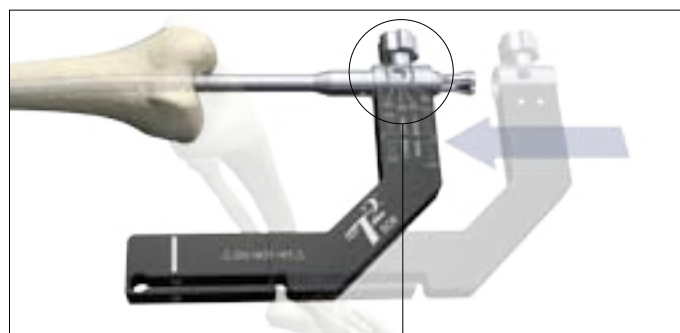

Fig. 22



Fig. 23

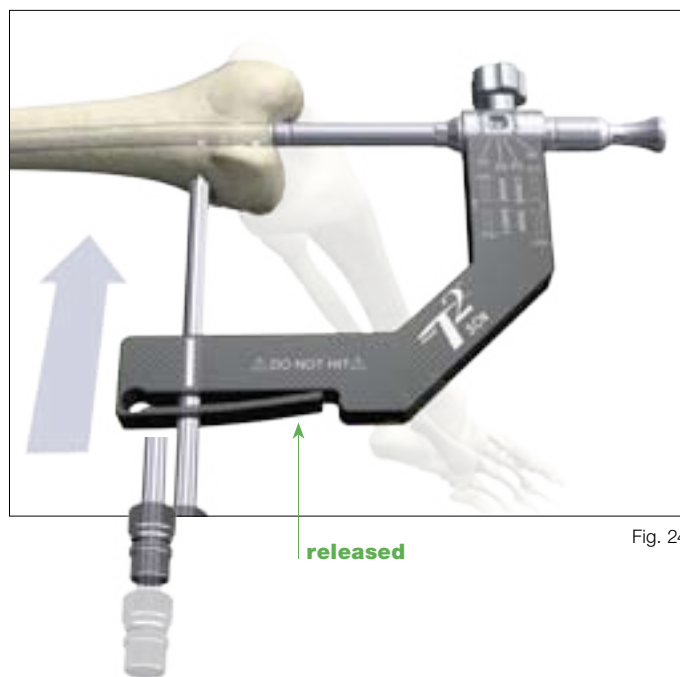

Fig. 24

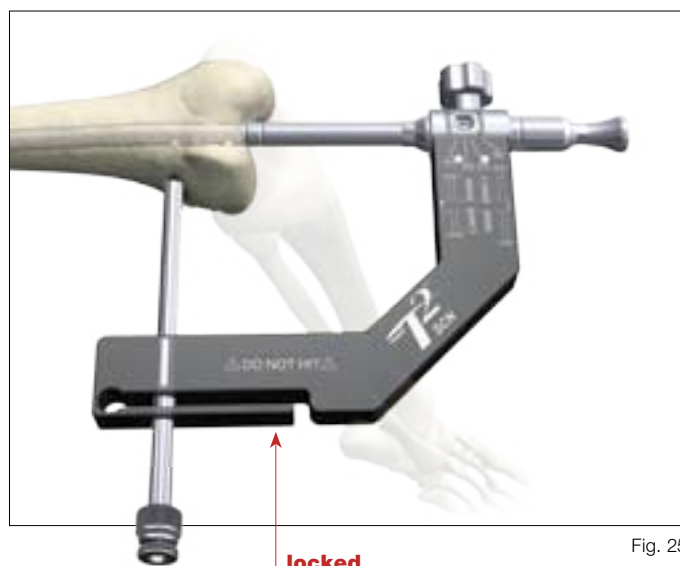

Fig. 25

Operative Technique

To ensure accurate drilling and determination of the screw length, use the center tipped 4.2×340mm calibrated Drill (1806-4260S).

After drilling both cortices, the screw length may be read directly off of the calibrated Drill at the end of the Drill Sleeve. If measurement with the long Screw Gauge (1806-0325) is preferred, first remove the Long Drill Sleeve and read the screw length directly at the end of the Long Tissue Protection Sleeve (Fig. 26 & 27).

Note:

The position of the end of the Drill as it relates to the far cortex is equal to where the end of the screw will be. Therefore, if the end of the Drill is 3mm beyond the far cortex, the end of the screw will also be 3mm beyond.

Note:

The Long Screw Gauge is calibrated so that with the bend at the end is pulled back flush with the far cortex, the screw tip will end 3mm beyond the far cortex (Fig. 27).

When the Long Drill Sleeve is removed, the correct Locking Screw is inserted through the Long Tissue Protection Sleeve using the Long Screwdriver Shaft (1806-0229) with Teardrop Handle (702429). The screw is advanced through both cortices (Fig. 28).

The screw design allows for full thread purchase to compensate for self tapping feature of the screws.

The screw is near its proper seating position when the groove around the shaft of the screwdriver is approaching the end of the Long Tissue Protection Sleeve (Fig. 29).

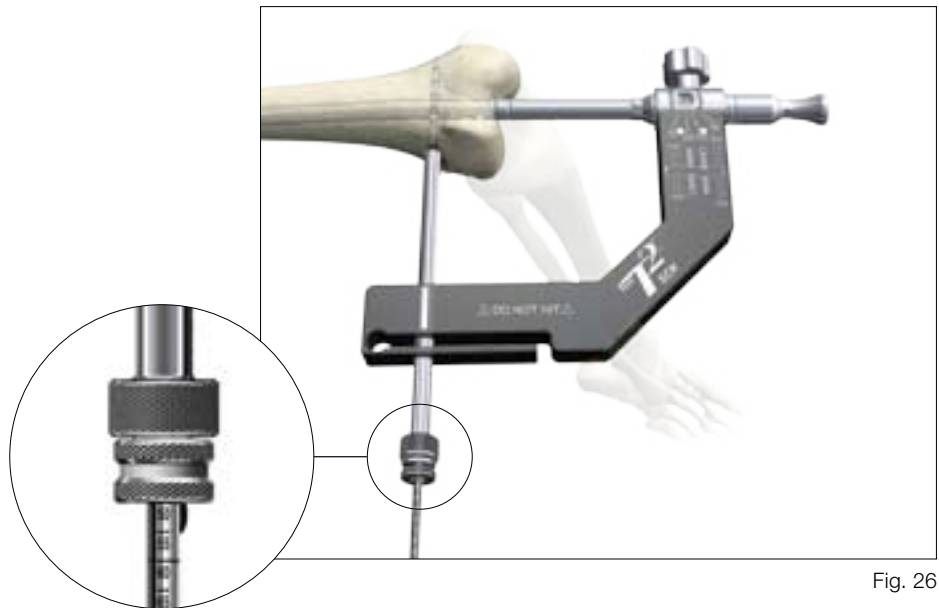

Fig. 26

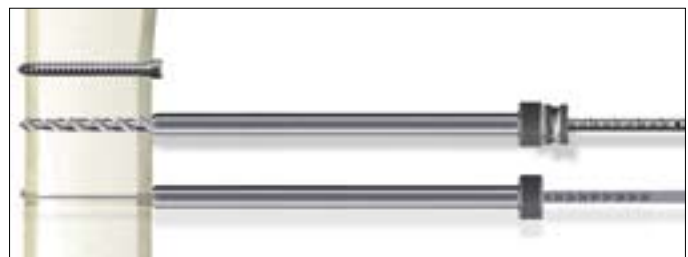

Fig. 27

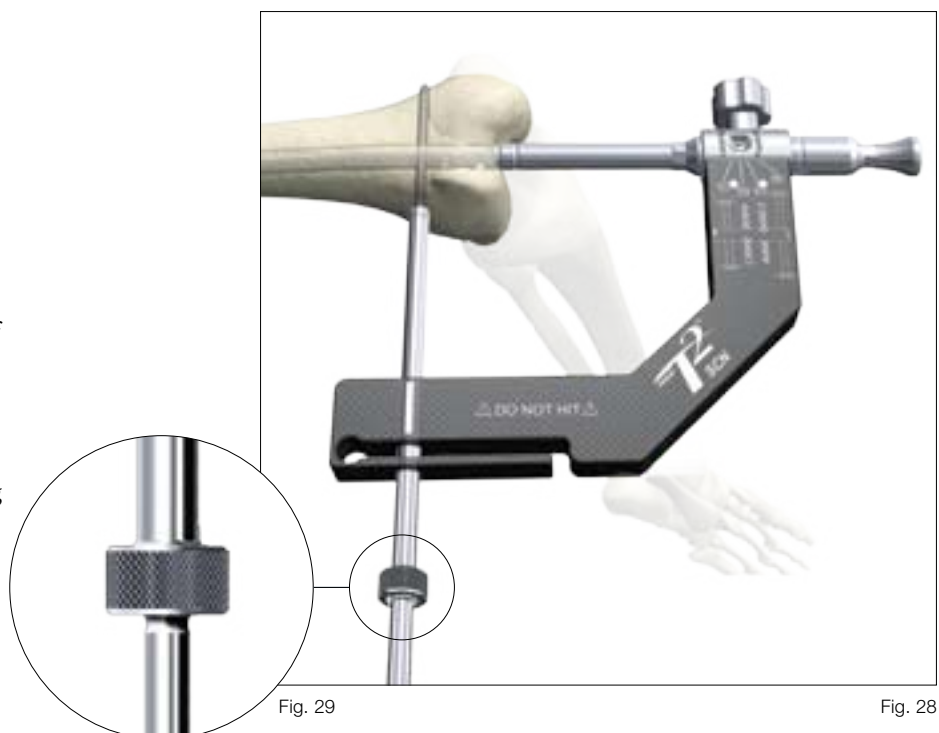

Fig. 29

Fig. 28

Operative Technique

5.7.2. Proximal Condyle Screw Locking

If a Condyle Screw is to be inserted, both cortices are drilled with the Ø 5×340mm Drill (1806-5020S) (Fig. 30).

After drilling both cortices, the screw length may be read directly off of the calibrated Drill at the end of the Long Drill Sleeve (Fig. 30a).

Note:

The measurement equals Condyle Screw fixation length (from top of the Condyle Screw head to the top of Condyle Nut head, as shown in Fig. 30a). The Condyle Screw length is defined with the Condyle Screw tip flush to the Condyle Nut head. The possible fixation length ranges from 2mm longer than the Condyle Screw length to 5mm shorter. Ensure that the Condyle Nut is tightened a minimum of 5 turns on the Condyle Screw!

The Condyle Screw K-Wire (0152-0218S) is inserted from the lateral side through the Long Tissue Protection Sleeve to the medial side (Fig. 31). At the medial point of the perforation, a skin incision is made for the Condyle Screw.

From the medial side, the Condyle Screw is now brought forward over the Condyle Screw K-Wire (0152-0218S) and inserted using the Condyle Screw Screwdriver (1806-0255).

To insert the Condyle Nut, the Long Tissue Protection Sleeve and the Long Drill Sleeve are removed, and the K-Wire is withdrawn to the medial side. This allows the Nut to be positioned between the Targeting Adapter and the level of the skin and onto the Condyle Screw K-Wire (Fig. 31).

Alternatively, if patient anatomy allows, the Condyle Screw may be introduced from Lateral to Medial in a similar manner as described above (Fig. 32).

Using both Condyle Screw Screwdrivers, the Condyle Nut and the Condyle Screw are tightened. Once tightened, the K-Wire is removed (Fig. 32).



Fig. 30



Fig. 30a



Fig. 31

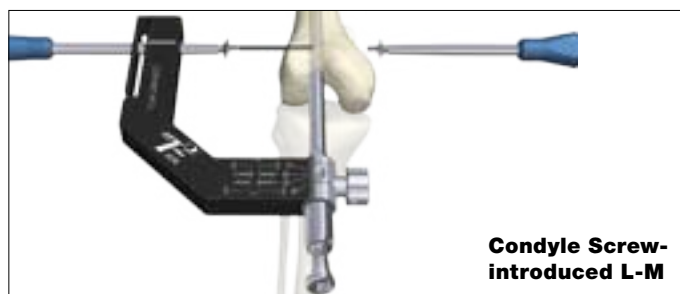

Fig. 32

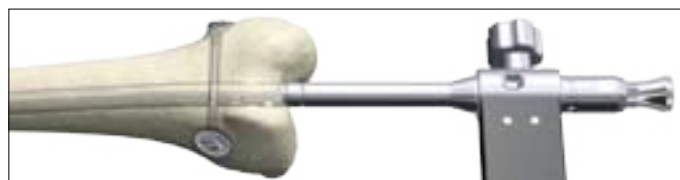

Fig. 33

Note:

In cases where the chosen condyle screw is too long it may be easier to extract the screw with the Revision Condyle Screwdriver Bit (1806-0257) placed on top of the Condyle Screwdriver.

Note:

Do not use the Revision Condyle Screwdriver Bit for Screw insertion and/or compression.

The adjustable screw washer of the Condyle Screw and the Condyle Nut adapt to the surface of the bone eliminating the need to countersink both (Fig. 33).

Note:

If necessary, contour the bone geometry to optimize the seating of the washer.

Operative Technique

5.7.3. Oblique Screw Locking

Turn and pull back the Targeting Arm around the Nail Adapter until the system is locked in the oblique plane to gain access to the most proximal oblique locking hole. The position is fixed by tightening the thumb screw.

Note:

Check that position 2 is indicated in the Locking Window (Fig. 34).

The Long Tissue Protection Sleeve (together with the Long Drill Sleeve and the Long Trocar) is inserted into the Targeting Arm by pressing the Safety Clip. To release the Tissue Protection Sleeve, the Safety Clip must be pressed again.

A small skin incision is made, and the assembly is pushed through until it is in contact with the cortex of the Femur. The Long Trocar is removed, with the Long Tissue Protection Sleeve and the Long Drill Sleeve remaining in position.

To ensure accurate drilling and easy determination of the screw length, use the center tipped 4.2×340mm calibrated Drill (1806-4260S). The centered Drill is forwarded through the Drill Sleeve and pushed onto the cortex (Fig. 35). After drilling both cortices, the screw length may be read directly off of the calibrated Drill at the end of the Drill Sleeve. If measurement with the Long Screw Gauge (1806-0325) is preferred, first remove the Long Drill Sleeve and read the screw length directly at the end of the Long Tissue Protection Sleeve (Fig. 27, page 16).

Note:

The position of the end of the Drill as it relates to the far cortex is equal to where the end of the screw will be. Therefore, if the end of the Drill is 3mm beyond the far cortex, the end of the screw will also be 3mm beyond.

When the Long Drill Sleeve is removed, the correct Locking Screw is

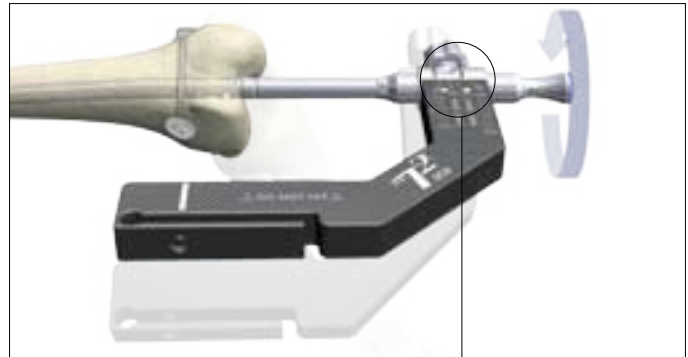

Fig. 34



Fig. 35



Fig. 36

inserted through the Long Tissue Protection Sleeve using the Long Screwdriver Shaft with Teardrop Handle. The screw is advanced through both cortices (Fig. 36). The screw is near its proper seating position when the groove around the shaft of the screwdriver is approaching the end of the Long Tissue Protection Sleeve.

Operative Technique

Turn and pull back the Targeting Arm around the Nail Adapter until the system is locked in the oblique plane to gain access to the most distal oblique locking hole (Fig. 37), the position is fixed by tightening the thumb screw.

Note:

Check that position 3 is indicated in the Locking Window (Fig. 37).

Repeat the locking procedure.

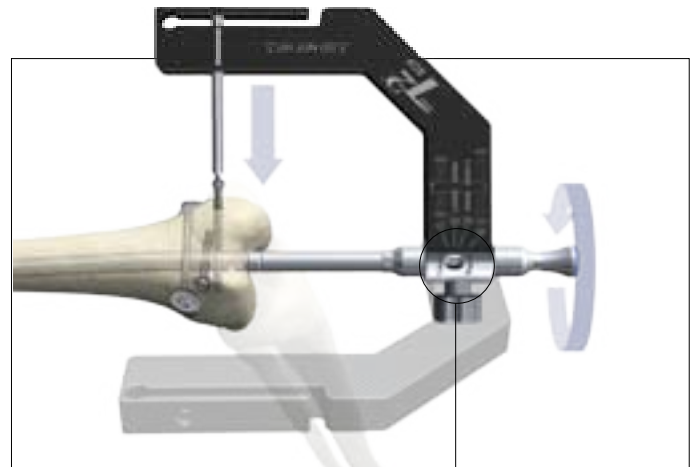

Fig. 37

5.7.4. Distal Locking - Fully Threaded or Condyle Screw

Turn the Targeting Arm around the Nail Adapter until the system is locked in the M/L plane to gain access to the most distal locking hole. (Fig. 38)
The position is fixed by tightening the thumb screw.

Note:

Check that position 4 is indicated in the Locking Window.

Depending on fracture patterns either a Fully Threaded Screw or a Condyle Screw can be inserted. See section 5.7.1. for using a Fully Threaded Screw. See section 5.7.2. for using a Condyle Screw (Fig. 39).

Note:

If necessary, contour the bone geometry to optimize the seating of the washer.

Note:

In cases where the chosen Condyle Screw is too long it may be easier to extract the Screw with the Revision Condyle Screwdriver Bit placed on top of the Condyle Screwdriver.

Note:

Do not use the Revision Condyle Screwdriver Bit for Screw insertion and/or compression.

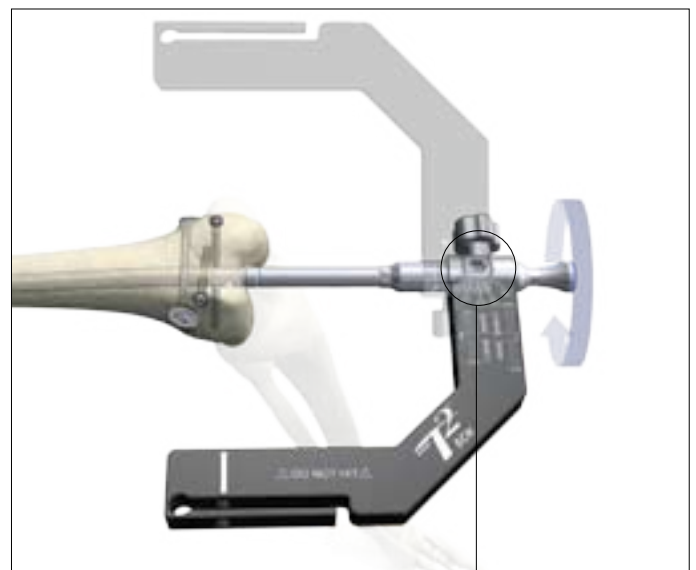

Fig. 38



Fig. 39

Operative Technique

5.8. Freehand Proximal locking

The freehand technique is used to insert locking screws into both A/P holes for the T2™ SCN Long version.

Freehand Proximal locking is not necessary for the T2™ SCN Short version. The use of a corresponding Targeting Arm Proximal for the T2™ SCN Short version, is described in Chapter 5.9.

Multiple locking techniques and radiolucent drill devices are available for freehand locking. The critical step with any freehand locking technique, proximal or distal, is to visualize a perfect round locking hole or perfect oblong locking hole with the C-Arm.

The center-tipped Ø4.2×230mm Drill is held at an oblique angle to the center of the locking hole (Fig. 40). Upon X-Ray verification, the Drill is placed perpendicular to the nail and drilled through the anterior and posterior cortex.

Confirm that the Drill passes through the hole in the nail in both the A/P and M/L planes by X-Ray.

After drilling both cortices (Fig. 41) the screw length may be read directly off of the Screw Gauge Femur (1806-0480).

Routine locking screw insertion is employed with the assembled Long Screwdriver Shaft and the Teardrop Handle.

Repeat the locking procedure to insert the second screw (Fig. 42).

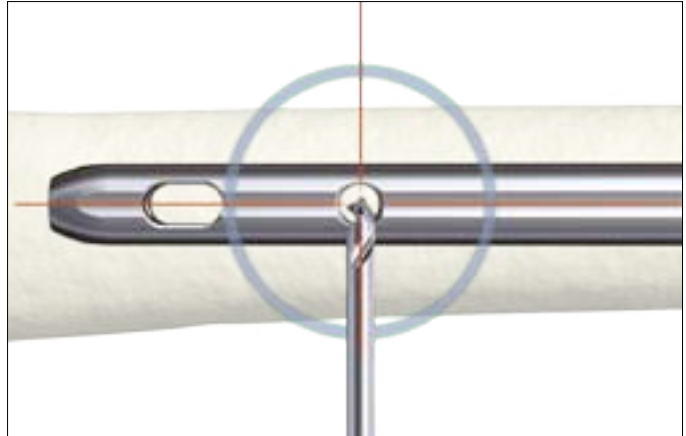

Fig. 40

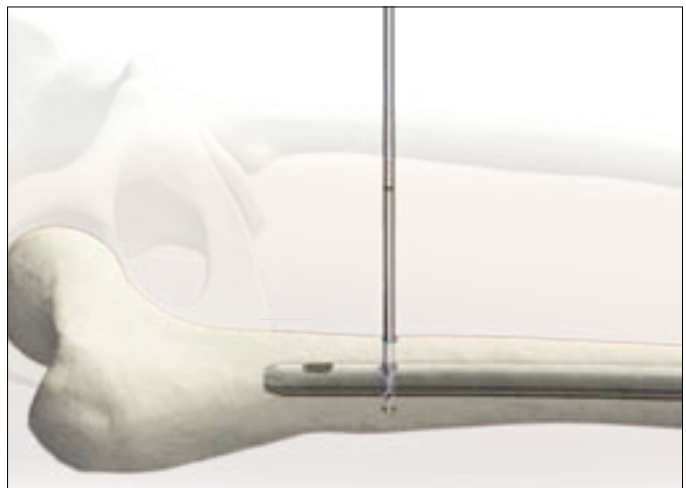

Fig. 41



Fig. 42

Operative Technique

5.9. Guided Proximal Locking T2™ SCN Short version

Remove the Targeting Arm, SCN and assemble the Targeting Arm Proximal, SCN onto the Nail Adapter (Fig. 43).

Note:

The Targeting Arm Proximal, SCN must be locked in position 1.

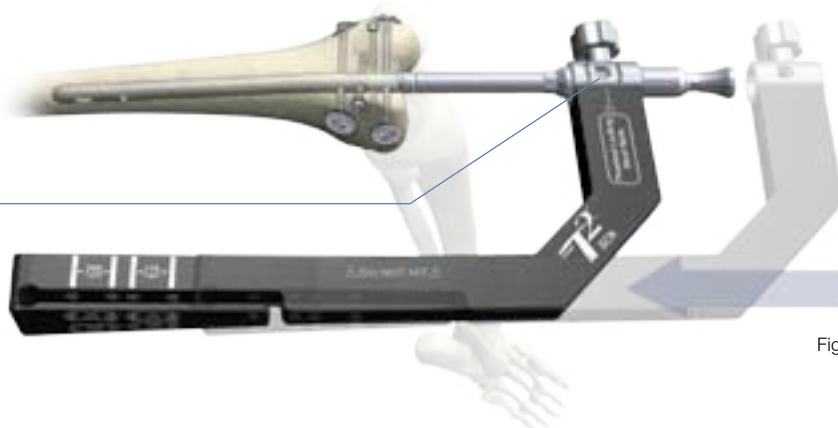

Fig. 43

The Targeting Arm Proximal, SCN is designed to provide guided proximal locking for the T2™ SCN Short version 170 and 200mm.

Note:

A load on the Targeting Arm Proximal, SCN may lead to a deflection of the Arm which will have a negative influence during the drilling procedure.

The Long Tissue Protection Sleeve together with the Long Drill Sleeve and the Long Trocar are inserted into the corresponding hole of the Targeting Arm for the selected nail (Fig. 44).

Routine drilling and the locking procedure are employed for the Proximal locking (Fig. 44–47).



Fig. 44



Fig. 45



Fig. 46



Fig. 47

Operative Technique

5.10. End Cap Insertion

After removal of the Target Device, the End Cap should be used in order to avoid bony ingrowth into the distal thread of the nail. One cannulated end cap is available for all nail sizes (Fig. 48).

Note:

The End Cap will lock the Locking Screw at the distal end of the nail. This will create a fixed angle between Nail and Locking Screw and prevent lateral sliding of the nail.

The End Cap is inserted with the Long Screwdriver Shaft (1806 - 0229) and the Teardrop Handle after intra-operative radiographs show satisfactory reduction and hardware implantation (Fig. 49). Fully seat the End Cap to minimize the potential for loosening.

Thoroughly irrigate the wound to prevent debris from remaining within the knee joint and close using standard technique.



Fig. 48



Fig. 49

Operative Technique

5.11. Nail Removal

Nail removal is an elective procedure. If needed, the End Cap and the most distal Screw are removed first with the Long Screwdriver Shaft and the Teardrop Handle (Fig. 50).

Note:

Special care must be taken to check if the nail moves off-center of the entry point when screws are removed. Any attempt to remove a nail that is off-center may result in fractures of the distal condylar region.

Note:

When extracting a Condyle Screw, it may be easier extracted with the Revision Condyle Screwdriver Bit placed on top of the Condyle Screwdrivers.

The Universal Rod is inserted into the driving end of the nail. All Locking Screws are then removed. The slotted hammer is used to extract the nail in a controlled manner (Fig. 51 & 52).



Fig. 50

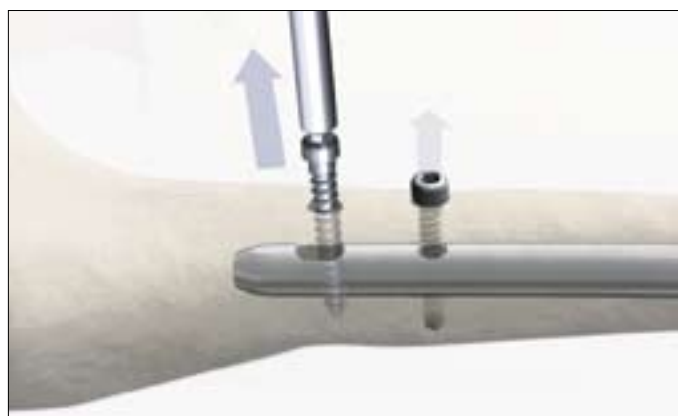

Fig. 51



Fig. 52

Ordering Information - Implants

T2™ SCN long



Standard REF	Diameter mm	Length mm
1826-0924S	9	240
1826-0926S	9	260
1826-0928S	9	280
1826-0930S	9	300
1826-0932S	9	320
1826-0934S	9	340
1826-0936S	9	360
1826-0938S	9	380
1826-0940S	9	400
1826-0942S	9	420
1826-0944S	9	440
1826-1024S	10	240
1826-1026S	10	260
1826-1028S	10	280
1826-1030S	10	300
1826-1032S	10	320
1826-1034S	10	340
1826-1036S	10	360
1826-1038S	10	380
1826-1040S	10	400
1826-1042S	10	420
1826-1044S	10	440
1826-1124S	11	240
1826-1126S	11	260
1826-1128S	11	280
1826-1130S	11	300
1826-1132S	11	320
1826-1134S	11	340
1826-1136S	11	360
1826-1138S	11	380
1826-1140S	11	400
1826-1142S	11	420
1826-1144S	11	440
1826-1224S	12	240
1826-1226S	12	260
1826-1228S	12	280
1826-1230S	12	300
1826-1232S	12	320
1826-1234S	12	340
1826-1236S	12	360
1826-1238S	12	380
1826-1240S	12	400
1826-1242S	12	420
1826-1244S	12	440
1826-1324S	13	240
1826-1326S	13	260
1826-1328S	13	280
1826-1330S	13	300
1826-1332S	13	320
1826-1334S	13	340
1826-1336S	13	360
1826-1338S	13	380
1826-1340S	13	400
1826-1342S	13	420
1826-1344S	13	440
1826-1424S	14	240
1826-1426S	14	260
1826-1428S	14	280
1826-1430S	14	300
1826-1432S	14	320
1826-1434S	14	340
1826-1436S	14	360
1826-1438S	14	380
1826-1440S	14	400
1826-1442S	14	420
1826-1444S	14	440

T2™ SCN short



REF	Diameter mm	Length mm
1826-0917S	9	170
1826-0920S	9	200
1826-1017S	10	170
1826-1020S	10	200
1826-1117S	11	170
1826-1120S	11	200
1826-1217S	12	170
1826-1220S	12	200
1826-1317S	13	170
1826-1320S	13	200
1826-1417S	14	170
1826-1420S	14	200

Ordering Information - Implants

5mm fully threaded Locking Screws



REF	Diameter mm	Length mm
1896-5025S	5	25.0
1896-5027S	5	27.5
1896-5030S	5	30.0
1896-5032S	5	32.5
1896-5035S	5	35.0
1896-5037S	5	37.5
1896-5040S	5	40.0
1896-5042S	5	42.5
1896-5045S	5	45.0
1896-5047S	5	47.5
1896-5050S	5	50.0
1896-5052S	5	52.5
1896-5055S	5	55.0
1896-5057S	5	57.5
1896-5060S	5	60.0
1896-5065S	5	65.0
1896-5070S	5	70.0
1896-5075S	5	75.0
1896-5080S	5	80.0
1896-5085S	5	85.0
1896-5090S	5	90.0
1896-5095S	5	95.0
1896-5100S	5	100.0
1896-5105S	5	105.0
1896-5110S	5	110.0
1896-5115S	5	115.0
1896-5120S	5	120.0

Condyle Screws



REF	Diameter mm	Length mm
1895-5040S	5	40
1895-5045S	5	45
1895-5050S	5	50
1895-5055S	5	55
1895-5060S	5	60
1895-5065S	5	65
1895-5070S	5	70
1895-5075S	5	75
1895-5080S	5	80
1895-5085S	5	85
1895-5090S	5	90
1895-5095S	5	95
1895-5100S	5	100
1895-5105S	5	105
1895-5110S	5	110
1895-5115S	5	115
1895-5120S	5	120

End Cap



REF	Diameter mm	Length mm
1826-0003S		

Condyle Nut





















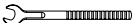
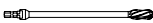



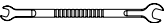
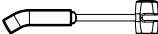



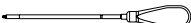

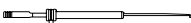

REF	Diameter mm	Length mm
1895-5001s		

Note:

Check with local representative regarding availability of nail sizes.

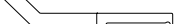
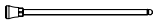
Implants in sterile packaging

Ordering Information - Instruments

REF	Description	REF	Description
Standard Instruments		Optional Instruments	
	0152-0218 K-Wire, Ø1.8×310mm (2×)		1806-0032 Awl Plug
	1806-0045 Awl, Straight		1806-4260S Drill Ø4.2×340mm, AO (2×)
	1806-0095 Guide Wire Handle		1806-4270S Drill Ø4.2×180mm, AO (2×)
	1806-0096 Guide Wire Handle Chuck		1806-5020S Drill Ø5.0×340mm, AO (2×)
	1114-6004 Spanner, SW 12		
	1806-2012 Rigid Reamer, Ø12mm		
	1806-0020 Guide Wire Ruler		
	1806-0050 K-Wire Ø3×285mm (2×)		
	1806-0110 Universal Rod		
	1806-0125 Reduction Spoon		
	1806-0130 Wrench, 8mm/10mm		
	1806-0170 Slotted Hammer		
	1806-0185 Tissue Protection Sleeve, Long		
	1806-0215 Drill Sleeve, Long		
	1806-0229 Screwdriver Shaft AO, Long		
	1806-0232 Screwdriver, Long		
	1806-0255 Screwdriver, Condyle Screw (2×)		
	1806-0257 Revision Condyle Screwdriver Bit		
	1806-0294 Screw Driver Shaft, 3.5×85mm		
	1806-0315 Trocar, Long		
	1806-0325 Screw Gauge, Long		
	1806-0350 Extraction Rod, Conical, 8mm		
	1806-0480 Screw Gauge, Femur		
	702429 Teardrop Handle, AO		
	703165 Protection Sleeve Retrograde		
	1806-3000 Target Device SCN, complete (Nail Adapter, Targeting Arm, Targeting Arm Proximal)		
	1806-3301 Nail Adapter, SCN		
	1806-3302 Targeting Arm, SCN		
	1806-3305 Targeting Arm Proximal, SCN		
	1806-3307 Nail Holding Screw, SCN		
	1806-3306 X-Ray Template, SCN		
	1806-4260 Drill Ø4.2×340mm, AO (2×)		
	1806-4270 Drill Ø4.2×180mm, AO (2×)		
	1806-5020 Drill Ø5.0×340mm, AO (2×)		
	1806-9200 Instrument Tray SCN		
	1806-9210 Add-on Instrument Tray SCN		

* Instruments designated "Outside of the U.S." may not be ordered for the U.S. market.

Ordering Information - Instruments

Bixcut™

Complete range of modular and fixed-head reamers to match surgeon preference and optimize O.R. efficiency, presented in fully sterilizable cases.

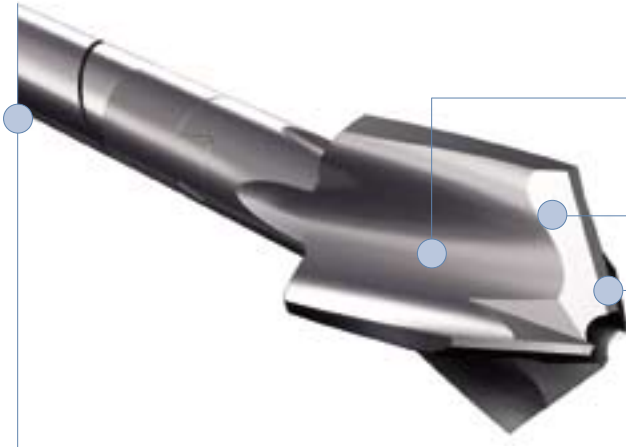

Large clearance rate resulting from reduced number of reamer blades coupled with reduced length of reamer head to give effective relief of pressure and efficient removal of material.

Cutting flute geometry optimized to lower pressure generation.

Forward- and side-cutting face combination produces efficient material removal and rapid clearance.

Double-wound shaft transmits torque effectively and with high reliability. Low-friction surface finish aids rapid debris clearance.

Smaller, 6 and 8mm shaft diameters significantly reduce IM pressure.

Typical Standard
Reamer Ø14mm

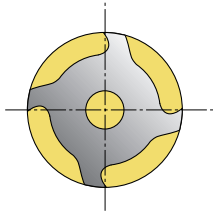

Clearance area:
32% of cross section

Bixcut™
Reamer Ø14mm

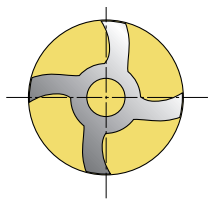

Clearance area:
59% of cross section

Recent studies¹ have demonstrated that the pressures developed within the medullary cavity through the introduction of unreamed IMnails can be far greater than those developed during reaming – but this depends very much upon the design of the reamer.

After a three year development study² involving several universities, the factors that determine the pressures and temperatures developed during reaming were clearly established. These factors were applied to the development of advanced reamers that demonstrate significantly better performance than the best of previous designs.

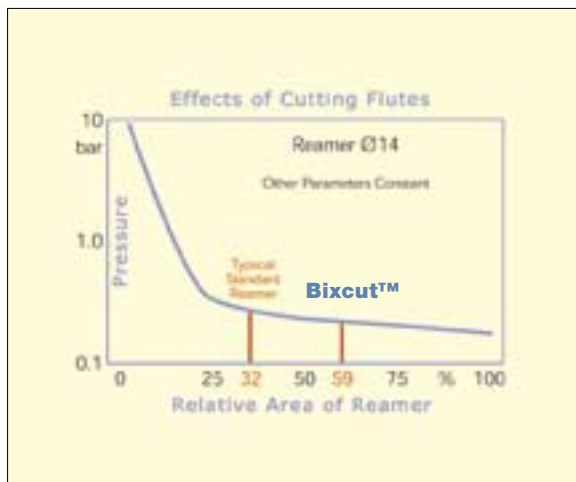

¹ Jan Paul M. Frolke, et al.; Intramedullary Pressure in Reamed Femoral Nailing with Two Different Reamer Designs., Eur. J. of Trauma, 2001 #5

² Medhi Massau, et al.; Pressure Changes During Reaming with Different Parameters and Reamer Designs, Clinical Orthopaedics and Related Research Number 373, pp. 295-303, 2000

Ordering Information - Instruments

Bixcut™ Modular Head

REF	Description	Diameter mm
0226-3090	Bixcut Head	9.0
0226-3095	Bixcut Head	9.5
0226-3100	Bixcut Head	10.0
0226-3105	Bixcut Head	10.5
0226-3110	Bixcut Head	11.0
0226-3115	Bixcut Head	11.5
0226-3120	Bixcut Head	12.0
0226-3125	Bixcut Head	12.5
0226-3130	Bixcut Head	13.0
0226-3135	Bixcut Head	13.5
0226-3140	Bixcut Head	14.0
0226-3145	Bixcut Head	14.5
0226-3150	Bixcut Head	15.0
0226-3155	Bixcut Head	15.5
0226-3160	Bixcut Head	16.0
0226-3165	Bixcut Head	16.5
0226-3170	Bixcut Head	17.0
0226-3175	Bixcut Head	17.5
0226-3180	Bixcut Head	18.0
0226-4185	Bixcut Head	18.5
0226-4190	Bixcut Head	19.0
0226-4195	Bixcut Head	19.5
0226-4200	Bixcut Head	20.0
0226-4205	Bixcut Head	20.5
0226-4210	Bixcut Head	21.0
0226-4215	Bixcut Head	21.5
0226-4220	Bixcut Head	22.0
0226-4225	Bixcut Head	22.5
0226-4230	Bixcut Head	23.0
0226-4235	Bixcut Head	23.5
0226-4240	Bixcut Head	24.0
0226-4245	Bixcut Head	24.5
0226-4250	Bixcut Head	25.0
0226-4255	Bixcut Head	25.5
0226-4260	Bixcut Head	26.0
0226-4265	Bixcut Head	26.5
0226-4270	Bixcut Head	27.0
0226-4275	Bixcut Head	27.5
0226-4280	Bixcut Head	28.0

Bixcut™ Shaft – AO fitting

REF	Description	Length mm
0226-3000	Shaft, AO	450
0226-8240	Shaft, AO	240

Bixcut™ Shaft – Modified Trinkle fitting (sterile) +

REF	Description	Length mm
0227-3000(S)	Shaft, Mod. Trinkle	450
0227-8240(S)	Shaft, Mod. Trinkle	240

Bixcut™ Trays

REF	Description
0225-6000	Tray, Modular Head (up to size 22.0mm)
0225-6001	Tray, Modular Head (up to size 28.0mm)
0225-8000	Tray, Fixed Head (up to size 18.0mm)

+ Use with Stryker Power Equipment

* Use with 2.2mm × 800mm Smooth Tip and
2.5mm × 800mm Ball Tip Guide wires only.

Ordering Information - Instruments

Bixcut™ Fixed Head – Modified Trickle fitting⁺

REF	Diameter mm	Length mm
0227-5060	6.0*	400
0227-5065	6.5*	400
0227-5070	7.0*	400
0227-6075	7.5	480
0227-6080	8.0	480
0227-6085	8.5	480
0227-6090	9.0	480
0227-6095	9.5	480
0227-6100	10.0	480
0227-6105	10.5	480
0227-6110	11.0	480
0227-8115	11.5	480
0227-8120	12.0	480
0227-8125	12.5	480
0227-8130	13.0	480
0227-8135	13.5	480
0227-8140	14.0	480
0227-8145	14.5	480
0227-8150	15.0	480
0227-8155	15.5	480
0227-8160	16.0	480
0227-8165	16.5	480
0227-8170	17.0	480
0227-8175	17.5	480
0227-8180	18.0	480

Bixcut™ Fixed Head – AO fitting

REF	Diameter mm	Length mm
0225-5060	6.0*	400
0225-5065	6.5*	400
0225-5070	7.0*	400
0225-6075	7.5	480
0225-6080	8.0	480
0225-6085	8.5	480
0225-6090	9.0	480
0225-6095	9.5	480
0225-6100	10.0	480
0225-6105	10.5	480
0225-6110	11.0	480
0225-8115	11.5	480
0225-8120	12.0	480
0225-8125	12.5	480
0225-8130	13.0	480
0225-8135	13.5	480
0225-8140	14.0	480
0225-8145	14.5	480
0225-8150	15.0	480
0225-8155	15.5	480
0225-8160	16.0	480
0225-8165	16.5	480
0225-8170	17.0	480
0225-8175	17.5	480
0225-8180	18.0	480

⁺ Use with Stryker Power Equipment

* Use with 2.2mm × 800mm Smooth Tip and 2.5mm × 800mm Ball Tip Guide wires only.

Notes

Notes

